

## 4LOW 46mm A/F HEXAGON HYDRAULIC WRENCH – TECHNICAL DATA

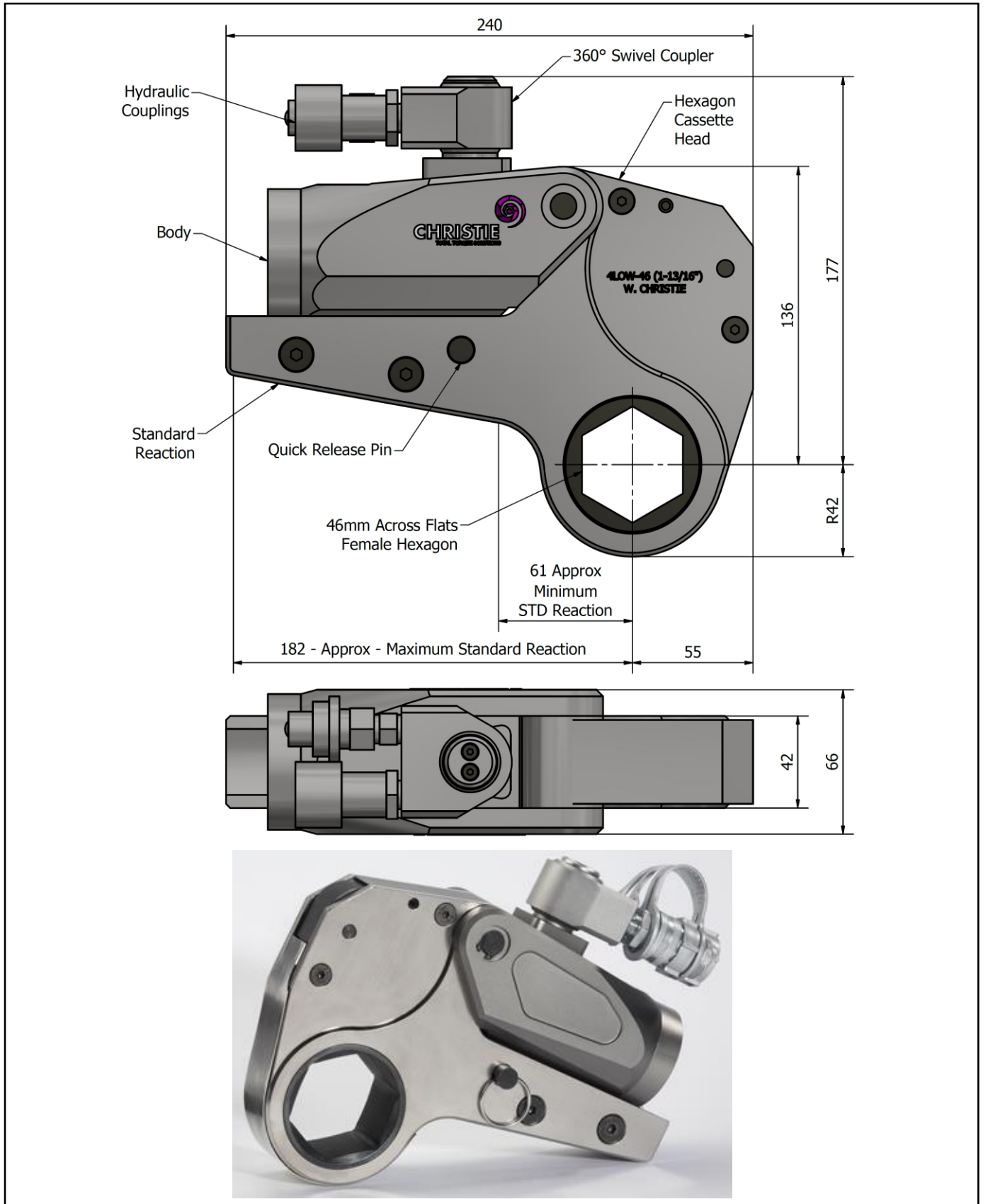

# 4LOW 46mm A/F HEXAGON HYDRAULIC WRENCH – TECHNICAL DATA

## DESCRIPTION

The 4LOW Hydraulic Torque Wrench is a direct fitting hydraulic driven power tool designed to accurately apply torque to tighten and remove threaded fasteners.

The wrench has an open hexagon designed to fit directly onto the nut or bolt head. This tooling is ideal for use on applications with limited overhead access or with fasteners having excessive thread protrusion.

The wrench incorporates a swivel coupler that can be rotated through a full 360° allowing hoses to be conveniently directed away from obstructions.

Torque is controlled by regulating the hydraulic pressure via a separate hydraulic power pack. Corresponding pressure settings and torques are determined using the graph provided.

The hexagon cassette head is quickly detachable from the body to allow different size hexagon cassettes to be fitted.

The LOW wrench must always be operated with the following:-

- Double Acting Hydraulic Power Pack capable of 10,000 psi (690 bar) with low pressure return
- Hydraulic Mineral Oil (None Synthetic, Grade 32 or equivalent)
- Hydraulic Hoses (Working Pressure 10,000 psi, 6mm Bore)

## SPECIFICATION

Hexagon Size:	46mm (Female)
Torque Accuracy:	+/- 3%
Minimum Output Torque:	440 Nm (324 lbf.ft)
Maximum Output Torque:	5,740 Nm (4,234 lbf.ft)
Maximum Working Pressure:	690 bar (10,000 psi)
Maximum Return Pressure:	50 bar (725 psi)
Total Weight (Including Reaction):	<7.0Kg (15.43 lbs)
Swivel Coupler Port Size:	1/4" NPT

## ACCESSORIES AVAILABLE

The following accessories are available upon request and can be custom made to suit requirements. Please contact W. Christie (Industrial) Limited for more information:-

- Special Reaction Extensions
- Alternative Cassette Sizes from 34mm A/F hexagon to 80mm A/F hexagon
- Hexagon Reducing Sleeves (for use on smaller bolt sizes)
- Male Hexagon Adaptors
- Male Square Adaptors

No statement or data within this literature is warranted or guaranteed to be accurate.



W. CHRISTIE (INDUSTRIAL) LTD  
CHRISTIE HOUSE  
MEADOWBANK ROAD  
ROTHERHAM  
SOUTH YORKSHIRE  
S61 2NF UK  
T: +44(0)1709 550088 F: +44(0)1709 550030  
E: [INFO@WCHRISTIE.COM](mailto:INFO@WCHRISTIE.COM) W: [WWW.WCHRISTIE.COM](http://WWW.WCHRISTIE.COM)