

LH30K 2-1/8" A/F STATIC ARM HYDRAULIC WRENCH TECHNICAL DATA

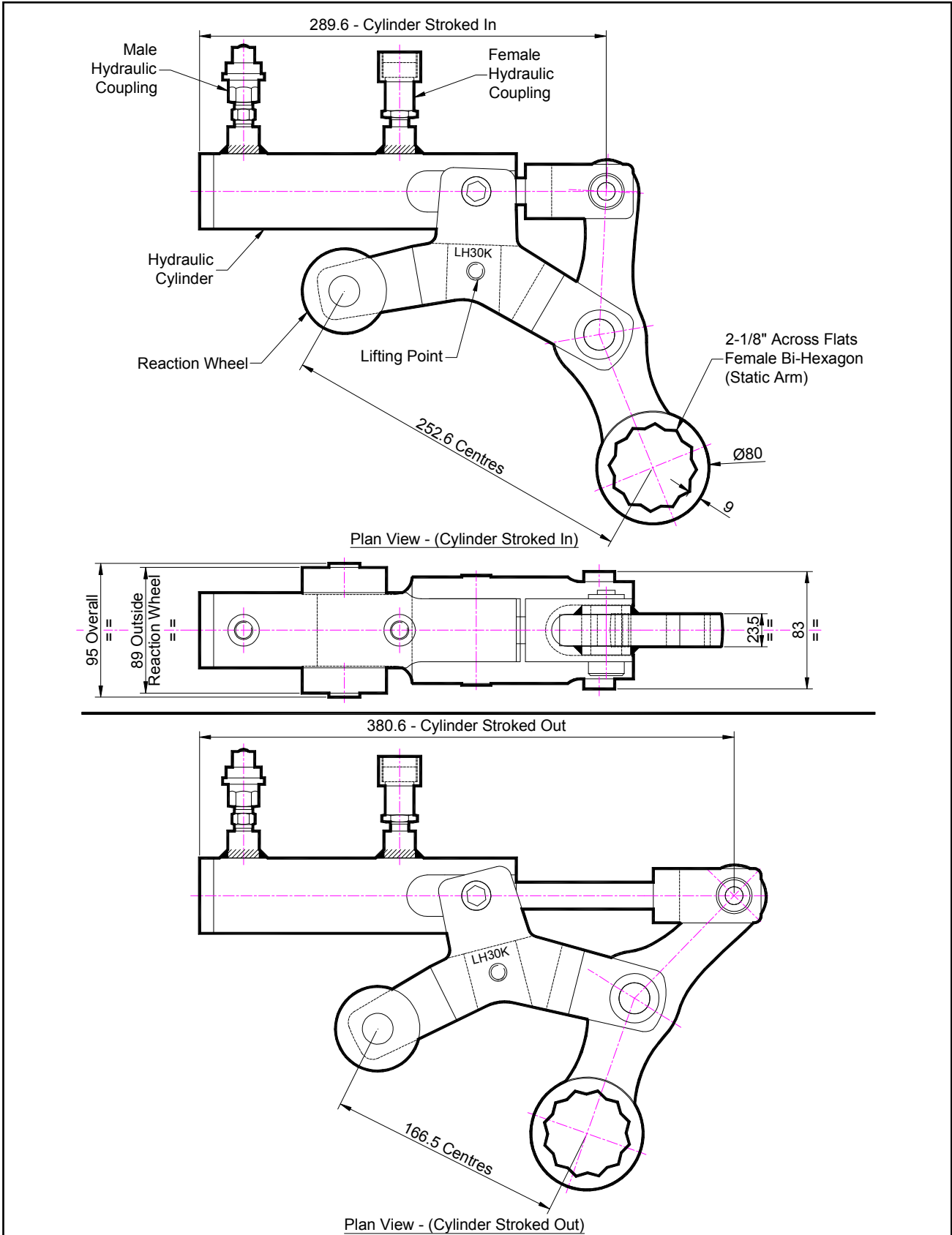

LH30K 2-1/8" STATIC ARM A/F HYDRAULIC WRENCH TECHNICAL DATA

DESCRIPTION

The Low Height (LH) Hydraulic wrench is a direct fitting hydraulic actuated power tool designed to accurately apply torque to tighten and remove threaded fasteners. The low height system is ideal for flange work with limited height access.

The reaction wheel of the LH wrench sits firmly on the rim of the flange. The static arm can be quickly changed for other hexagon sizes.

The unit can be adapted to suit many other specific bolting applications. This tool offers unique solutions with unchallenged access to those awkward bolts.

The LH wrench must always be operated with the following:-

- Double Acting Hydraulic Power Pack capable of 10,000 psi (690 bar) with low pressure return
- Hydraulic Mineral Oil (None Synthetic, Grade 32 or equivalent)
- Hydraulic Hoses (Working Pressure 10,000 psi, 6mm Bore)

SPECIFICATION

Bi-Hexagon Size	2-1/8" (Female)
Direction:	Forward & Reverse
Torque Accuracy:	+/- 5%
Minimum Output Torque:	1,480 Nm (1,080 Lbf.ft)
Maximum Output Torque:	7,400 Nm (5,400 Lbf.ft)
Maximum Working Pressure:	690 bar (10,000 psi)
Maximum Return Pressure:	50 bar (725 psi)
Total Weight:	9 Kg (19.85 lbs)
Cylinder Port Size:	1/4" NPT
Angle Per Stroke:	41.5°

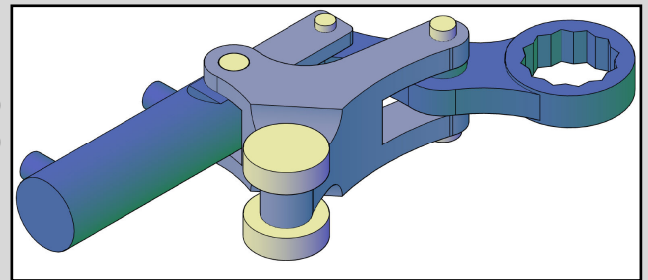

ACCESSORIES AVAILABLE

The following accessories are available upon request and can be custom made to suit requirements. Please contact W. Christie (Industrial) Limited for more information:-

- Alternative static arm sizes available up to 70mm (2-3/4") A/F Bi-Hexagon
- Ratchet arm sizes available up to 70mm (2-3/4") A/F Hexagon

RELATED TECHNICAL DATA SHEETS

The following technical data sheets may be of interest. Please contact W. Christie (Industrial) Limited for more information:-

- ADR70MD-LPR Power Pack (Air Actuated)
- ADR70XD-LPR Power Pack (Air Actuated)
- EDR70M-LPR Power Pack (Electrically Actuated)
- EDR70X-LPR Power Pack (Electrically Actuated)

No statement or data within this literature is warranted or guaranteed to be accurate.